

Endo-therapeutic  
solutions for efficient  
endoscopy



**GAOTOTEC**<sup>®</sup>



# GAOTOTEC

Becoming better every day.  
Making every day better.

Modern endoscopy is in a state of constant change. New medical findings require new technological solutions. At the same time, the work requirements of doctors and nurses in endoscopy and treatment of their patients keep changing daily.

Since its founding in 2005, ATE MEDICAL with its brand GAOTOTEC has focused exactly on this goal: Helping doctors to sustainably improve the health of their patients based on their individual needs. These solutions are continuously enhanced, not just to meet but surpass these needs and create new opportunities.

Getting better all the time – that is GAOTOTEC’s mission in the development and manufacture of high-end endotherapeutic accessories. At the same time, it is also a promise to physicians all over the world: Creating better solutions characterized by uncompromising quality that will help users perform more effectively.

Building on years of intense research and development, it is primarily the close collaboration with physicians and their teams which lets GAOTOTEC excel, driving us forward each day. Only in this way can we perceive future needs and expectations to turn them into modern solutions today.



**JIANGSU ATE MEDICAL TECHNOLOGY CO., LTD**  
No. 8, Lanxiang Road  
Wujin Economic Development Zone  
213000 Jiangsu, China

Tel: +86-519-85288988  
Fax: +86-519-85288060  
E-Mail: [sales@ate-medical.com](mailto:sales@ate-medical.com)  
Web: [www.ate-medical.com](http://www.ate-medical.com)

## International standards.

In our production site in China experienced specialists care for the highest manufacturing quality based on international standards. Covering a total area of approximately 3,000m<sup>2</sup>, about 60 qualified, well-trained employees, technicians, and engineers work on modern production facilities and clean rooms with class 100,000 standard. This guarantees a reliable production at the highest level.



## Controlled quality.

At GAOTOTEC quality has the highest status. Each instrument is subjected to strictly control during manufacture to ensure the highest level of quality assurance. Only when its functioning and processing are 100% perfectly, the instrument is meant for the ambitious work in modern clinics and medical practices and can carefully packaged, be shipped out.

Of course, all solutions of GAOTOTEC accord to certification DIN EN ISO 13485 and fulfil the stringent requirements of directive 93/42 EEC concerning medical devices.



## Accessories for daily routine.

GAOTOTEC provides physicians worldwide with reliable disposable endo-therapeutic disposable instruments for endoscopic daily routine. The range meets the highest standards and is continually expanding.



Biopsy forceps: P4



Disposable grasping forceps: P6



Disposable grasping basket: P8

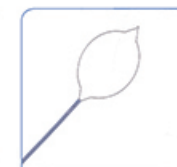

Disposable polypectomy snare: P10



Disposable grasping net-shape: P11



Injection needles: P12

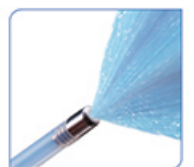

Spray catheter: P14



# Biopsy forceps

Quality and ergonomics perfectly combined.



The disposable biopsy forceps from GAOTOTEC stand out due to their high quality and ergonomic design. These features enable an easy and safe removal of tissue samples or polyps. Thanks to the first class manufacture, the biopsy forceps can be inserted very smoothly into the working channel and can be controlled precisely even with sharply angled endoscopes. The extra-sharp jaws can be closed accurately, thus ensuring a clean cut with minimal effort.

The extensive range offers the perfect solution for each application: whether with spike or without, with smooth or serrated jaws, with coating or without.

## Special features:

- High-quality materials and manufacture
- Simple and precise to use
- Sharp cutting edge for diagnostically conclusive biopsies
- Full closure of the cutting edges
- Special scissor design fits for the working channel
- Extensive product range



**JIANGSU ATE MEDICAL TECHNOLOGY CO., LTD**  
No. 8, Lanxiang Road  
Wujin Economic Development Zone  
213000 Jiangsu, China

Tel: +86-519-85288988  
Fax: +86-519-85288060  
E-Mail: [sales@ate-medical.com](mailto:sales@ate-medical.com)  
Web: [www.ate-medical.com](http://www.ate-medical.com)



## Ergonomic handle for optimum control.

For precise control of the jaw each biopsy forceps possess an ergonomically designed handle. It is particularly comfortable to hold, what makes the work easy and relaxed. Every the smallest rotation or movement of the handle is passed exactly on the jaw part so that this is controlled absolutely reliable.



	Model	Diameter of jaws(mm)	length(mm)
	Uncoated, without spike		
	ATE-QYQ-A-18x1050	1.8	1,050
	ATE-QYQ-A-18x1200	1.8	1,200
	ATE-QYQ-A-18x1600	1.8	1,600
	ATE-QYQ-A-23x1600	2.3	1,600
	ATE-QYQ-A-23x1800	2.3	1,800
	ATE-QYQ-A-23x2300	2.3	2,300
	Uncoated, with spike		
	ATE-QYQ-B-23x1600	2.3	1,600
	ATE-QYQ-B-23x1800	2.3	1,800
	ATE-QYQ-B-23x2300	2.3	2,300
	Coated, without spike		
	ATE-QYQ-C-18x1050	1.8	1,050
	ATE-QYQ-C-18x1200	1.8	1,200
	ATE-QYQ-C-18x1600	1.8	1,600
	ATE-QYQ-C-23x1600	2.3	1,600
	ATE-QYQ-C-23x1800	2.3	1,800
	ATE-QYQ-C-23x2300	2.3	2,300
	Coated, with spike		
	ATE-QYQ-D-23x1600	2.3	1,600
	ATE-QYQ-D-23x1800	2.3	1,800
	ATE-QYQ-D-23x2300	2.3	2,300
	With alligator jaws, uncoated, without spike		
	ATE-QYQ-E-23x1600	2.3	1,600
	ATE-QYQ-E-23x1800	2.3	1,800
	ATE-QYQ-E-23x2300	2.3	2,300
	With alligator jaws, uncoated, with spike		
	ATE-QYQ-F-23x1600	2.3	1,600
	ATE-QYQ-F-23x1800	2.3	1,800
	ATE-QYQ-F-23x2300	2.3	2,300
	With alligator jaws, coated, without spike		
	ATE-QYQ-G-23x1600	2.3	1,600
	ATE-QYQ-G-23x1800	2.3	1,800
	ATE-QYQ-G-23x2300	2.3	2,300
	With alligator jaws, coated, with spike		
	ATE-QYQ-H-23x1600	2.3	1,600
	ATE-QYQ-H-23x1800	2.3	1,800
	ATE-QYQ-H-23x2300	2.3	2,300



# Disposable grasping forceps

Everything in a safe grip.

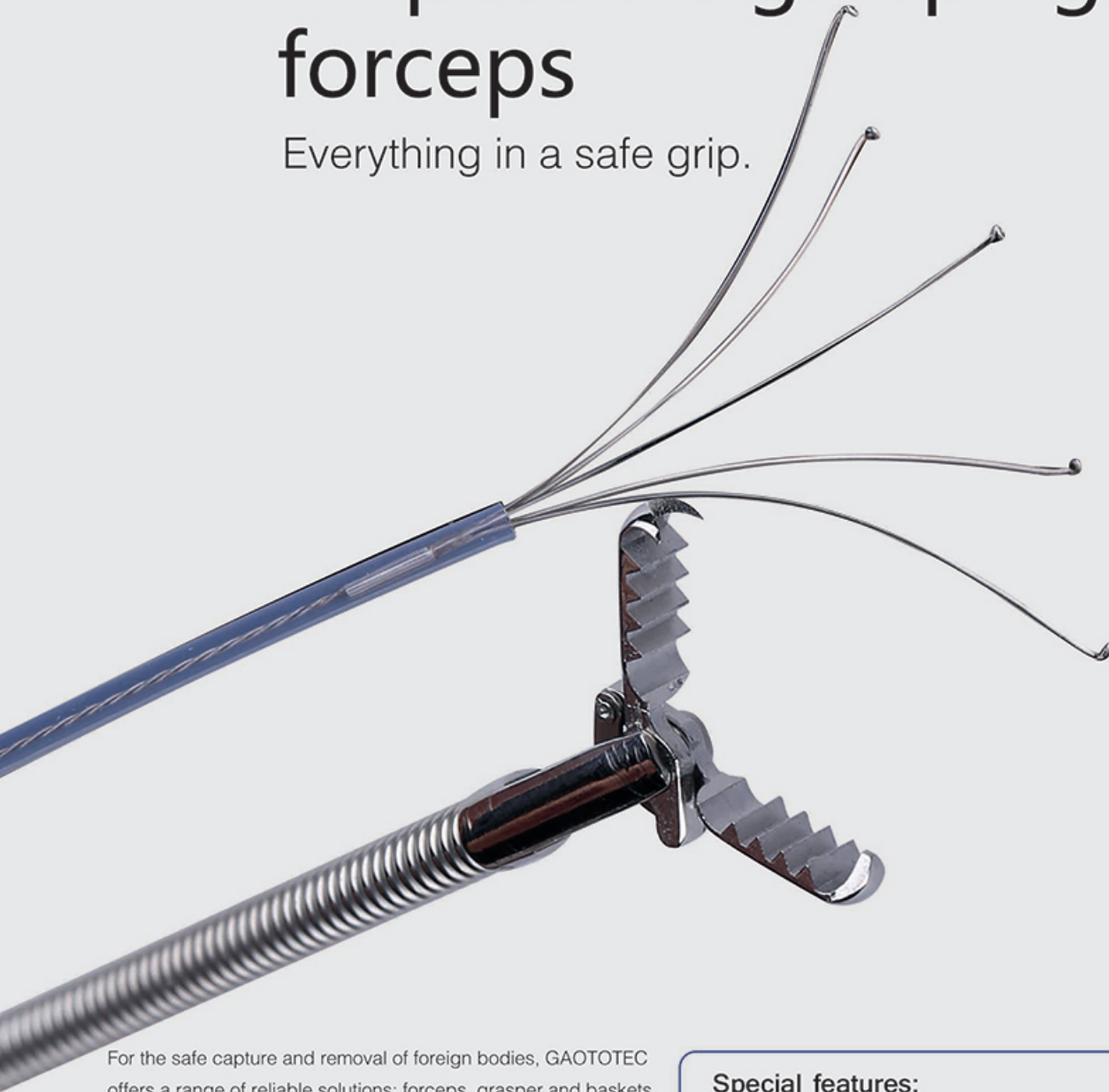

For the safe capture and removal of foreign bodies, GAOTOTEC offers a range of reliable solutions: forceps, grasper and baskets. Each instrument is made of high quality material and perfectly processed. For maximum grip the toothed forceps have two sharp hooks at the distal end. The graspers are equipped with smooth polished headboards to avoid injury to the patient or damage to the endoscope. The grasping baskets can also be used for the safe extraction of biliary stones. Their extraction baskets consists of special steel that is particularly flexible and can be easily moved in and out.

## Special features:

- Large opening angle or basket diameter for removal large foreign bodies
- Grasper and basket with quality PTFE covering
- Easy to insert even in complicated location
- Ergonomic handle for one-hand operation
- Excellent cost-performance ratio







**JIANGSU ATE MEDICAL TECHNOLOGY CO., LTD**  
No. 8, Lanxiang Road  
Wujin Economic Development Zone  
213000 Jiangsu, China

Tel: +86-519-85288988  
Fax: +86-519-85288060  
E-Mail: [sales@ate-medical.com](mailto:sales@ate-medical.com)  
Web: [www.ate-medical.com](http://www.ate-medical.com)



## Efficient control by 3-ring handle.

The 3-ring handle combines several advantages. Thanks to its ergonomic design, the handle is extremely user-friendly and easy to operate with one hand. At the same time, it relays every movement and rotation exactly to the forceps, grasper or basket, what makes the intervention even safer.

	Model	Diameter of the outer tube(mm)	length(mm)
	<b>Alligator jaw</b>		
	ATE-YWQ-CXDZ-18x1600	1.8	1600
	ATE-YWQ-CXDZ-23x1600	2.3	1600
	ATE-YWQ-CXDZ-23x2300	2.3	2300
	<b>Triple-teeth design</b>		
	ATE-YWQ-3ZX-18x1600	1.8	1600
	ATE-YWQ-3ZX-23x1600	2.3	1600
	ATE-YWQ-3ZX-23x2300	2.3	2300
	<b>Quad-teeth design</b>		
	ATE-YWQ-4ZX-18x1600	1.8	1600
	ATE-YWQ-4ZX-23x1600	2.3	1600
	ATE-YWQ-4ZX-23x2300	2.3	2300
	<b>Five-teeth design</b>		
	ATE-YWQ-5ZX-18x1600	1.8	1600
	ATE-YWQ-5ZX-23x1600	2.3	1600
	ATE-YWQ-5ZX-23x2300	2.3	2300





# Disposable grasping forceps

Everything in a safe grip.

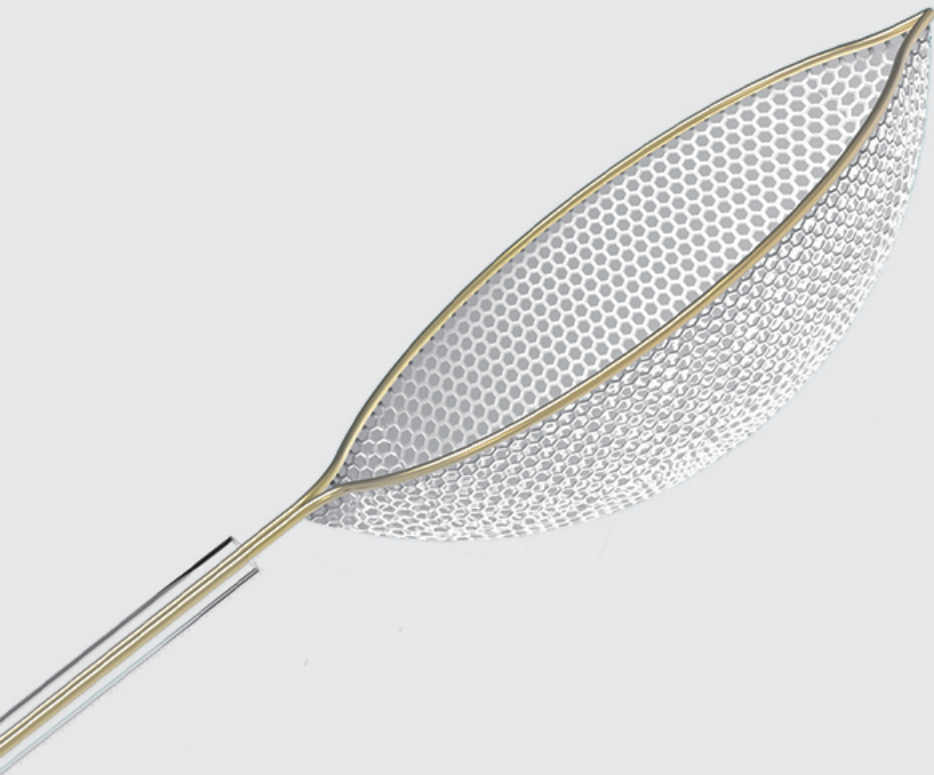

Usage : It is used to grasp and remove foreign body from the alimentary tract in human body in combination with endoscope.

## Special features:

- Integral rotation handle
- With good flexibility and net design, it can accurately and firmly grasp the foreign body.
- Single use, avoiding cross contamination
- ESD and EMR's indispensable partner.the clots,polyps, tissues can be thoroughly retrieved.



**JIANGSU ATE MEDICAL TECHNOLOGY CO., LTD**  
No. 8, Lanxiang Road  
Wujin Economic Development Zone  
213000 Jiangsu, China

Tel: +86-519-85288988  
Fax: +86-519-85288060  
E-Mail: [sales@ate-medical.com](mailto:sales@ate-medical.com)  
Web: [www.ate-medical.com](http://www.ate-medical.com)



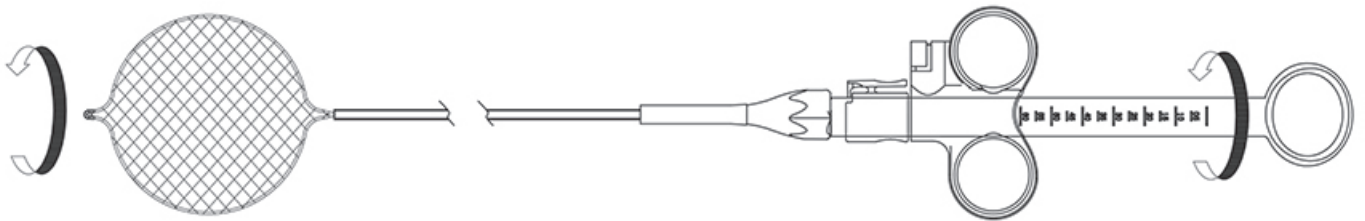
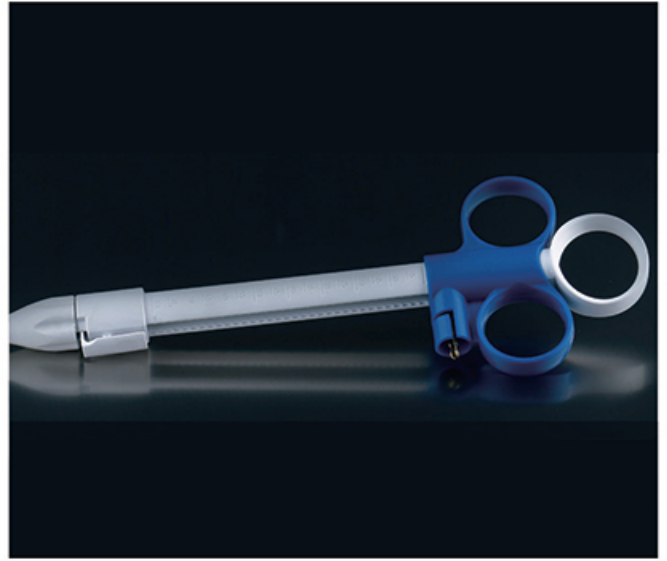
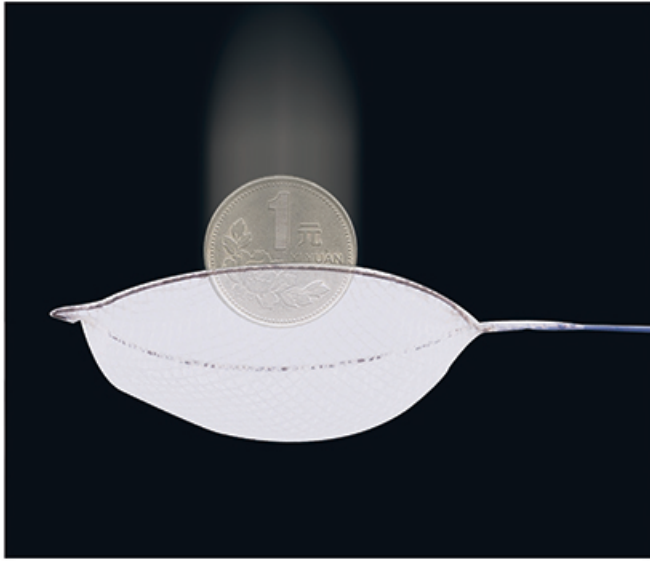

The design of the handle is rotatable , the net shap grasper design avoid the lost of samples, deeper elastic nylon net , which will efficiently filter out the natural tract fluid, it is good for grasp and control .

Model	Diameter of the outer tube(mm)	Length(mm)	Actual Opening width
ATE-YWQ-TY-18x1600x20	1.8	1600	15
ATE-YWQ-TY-23x1600x20	2.3	1600	15
ATE-YWQ-TY-23x1600x30	2.3	1600	25
ATE-YWQ-TY-23x1600x40	2.3	1600	35
ATE-YWQ-TY-23x2300x20	2.3	2300	15
ATE-YWQ-TY-23x2300x30	2.3	2300	25
ATE-YWQ-TY-23x2300x40	2.3	2300	35

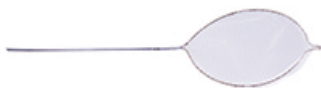



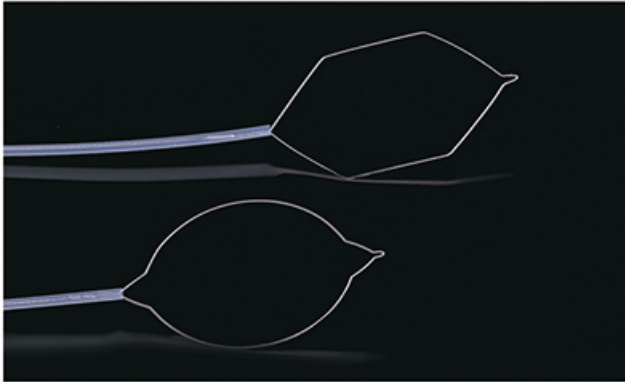

# Disposable polypectomy snare



### Special features:

medical grade stainless wire, high grade without deformation  
 Connection is safe and reliable

Usage : Removal of polyps or other excess tissues in the digestive tract used with diathermic energy.

	Model	Diameter of the outer tube(mm)	Length(mm)	Trap open width(mm)
	<b>The Oval</b>			
	ATE-QTQ-TY-18x500X10	1.8	500	10
	ATE-QTQ-TY-18x1200X15	1.8	1200	15
	ATE-QTQ-TY-23x1600X20	2.3	1600	20
	ATE-QTQ-TY-23x2300X25	2.3	2300	25
	<b>Hexagon-shape</b>			
	ATE-QTQ-LJ-18x500X10	1.8	500	10
	ATE-QTQ-LJ-18x1200X15	1.8	1200	15
	ATE-QTQ-LJ-23x1600X20	2.3	1600	20
	ATE-QTQ-LJ-23x2300X25	2.3	2300	25



# Disposable grasping basket

Everything in a safe grip.

Usage : It is used to grasp and remove foreign body from the alimentary tract in human body in combination with endoscope.

## Special features:

- Integral rotation handle
- With good flexibility and net design, it can accurately and firmly grasp the foreign body.
- Disposable use, avoiding cross contamination
- ESD and EMR's indispensable partner.the clots,polyps, tissues can be thoroughly retrieved.

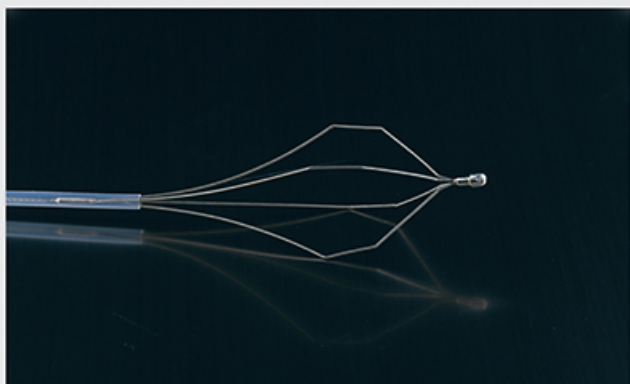

## Efficient control by 3-ring handle.

The 3-ring handle combines several advantages. Thanks to its ergonomic design, the handle is extremely user-friendly and easy to operate with one hand. At the same time, it relays every movement and rotation exactly to the forceps, grasper or basket, what makes the intervention even safer.

Model	Diameter of the outer tube(mm)	Length(mm)	网篮折角 Opening width
ATE-YWQ-ZJ-18x1600x15	1.8	1600	15
ATE-YWQ-ZJ-23x1600x15	2.3	1600	15
ATE-YWQ-ZJ-23x1600x25	2.3	1600	25
ATE-YWQ-ZJ-23x1600x35	2.3	1600	35
ATE-YWQ-ZJ-23x2300x15	2.3	2300	15
ATE-YWQ-ZJ-23x2300x25	2.3	2300	25
ATE-YWQ-ZJ-23x2300x35	2.3	2300	35





# Injection needles

Precise puncture in all areas.



**Class III registration certificate**  
**Exclusive patented design**

These disposable injection needles make sure that you get the highest reliability at injections such as in endoscopic mucosal resection. The stainless steel needle with a XX precision sharpening provides an optimal and easy puncture. The transparent PTFE-tube also enhances the rigidity, which optimizes the control of the needle once more. To prevent damage to the working channel, the needle is secured in the tube.

GAOTOTEC offers the injection needles in different lengths and with different diameters.

#### Special features:

- Needle with extremely sharp precision cut
- Handle with ergonomic design
- Safety lock for controlled needle handling
- Different needle lengths and diameters
- Stif, transparent PTFE tube to prevent kinking



**JIANGSU ATE MEDICAL TECHNOLOGY CO., LTD**  
No. 8, Lanxiang Road  
Wujin Economic Development Zone  
213000 Jiangsu, China

Tel: +86-519-85288988  
Fax: +86-519-85288060  
E-Mail: [sales@ate-medical.com](mailto:sales@ate-medical.com)  
Web: [www.ate-medical.com](http://www.ate-medical.com)



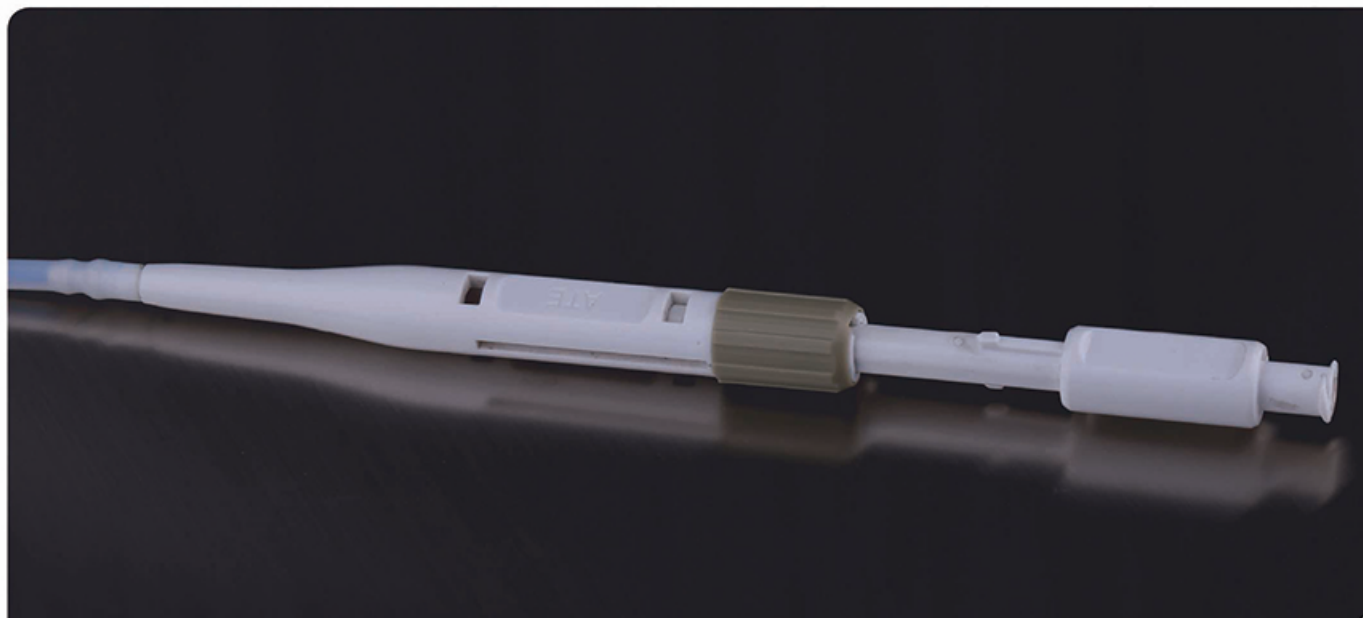

## User-friendly control handle with safety lock.

The slim and thus particularly ergonomic handle offers maximum control of the needle. The safety-lock prevents inadvertent motion of the needle while the insertion of the instrument. Damage on the working channel will be safely avoided.

Model	Diameter of the outer tube	length(mm)	diameter(mm)	length(mm)
<b>Injection needle</b>				
ATE-ZSZ-18x1200x25x4	1.8	1200	25G	4
ATE-ZSZ-18x1800x25x6	1.8	1800	25G	6
ATE-ZSZ-23x1600x23x5	2.3	1600	23G	5
ATE-ZSZ-23x2300x23x5	2.3	2300	23G	5
ATE-ZSZ-23x1800x21x4	2.3	1800	21G	4
ATE-ZSZ-23x1800x21x5	2.3	1800	21G	5
ATE-ZSZ-23x1800x21x6	2.3	1800	21G	6
ATE-ZSZ-23x1800x23x4	2.3	1800	23G	4
ATE-ZSZ-23x1800x23x5	2.3	1800	23G	5
ATE-ZSZ-23x1800x23x6	2.3	1800	23G	6
ATE-ZSZ-23x1800x25x4	2.3	1800	25G	4
ATE-ZSZ-23x1800x25x5	2.3	1800	25G	5
ATE-ZSZ-23x1800x25x6	2.3	1800	25G	6
ATE-ZSZ-23x2300x21x4	2.3	2300	21G	4
ATE-ZSZ-23x2300x21x5	2.3	2300	21G	5
ATE-ZSZ-23x2300x21x6	2.3	2300	21G	6
ATE-ZSZ-23x2300x23x4	2.3	2300	23G	4
ATE-ZSZ-23x2300x23x5	2.3	2300	23G	5
ATE-ZSZ-23x2300x23x6	2.3	2300	23G	6
ATE-ZSZ-23x2300x25x4	2.3	2300	25G	4
ATE-ZSZ-23x2300x25x5	2.3	2300	25G	5
ATE-ZSZ-23x2300x25x6	2.3	2300	25 G	6





# Disposable Endoscopic Hemoclips

Easy Effective Exactly

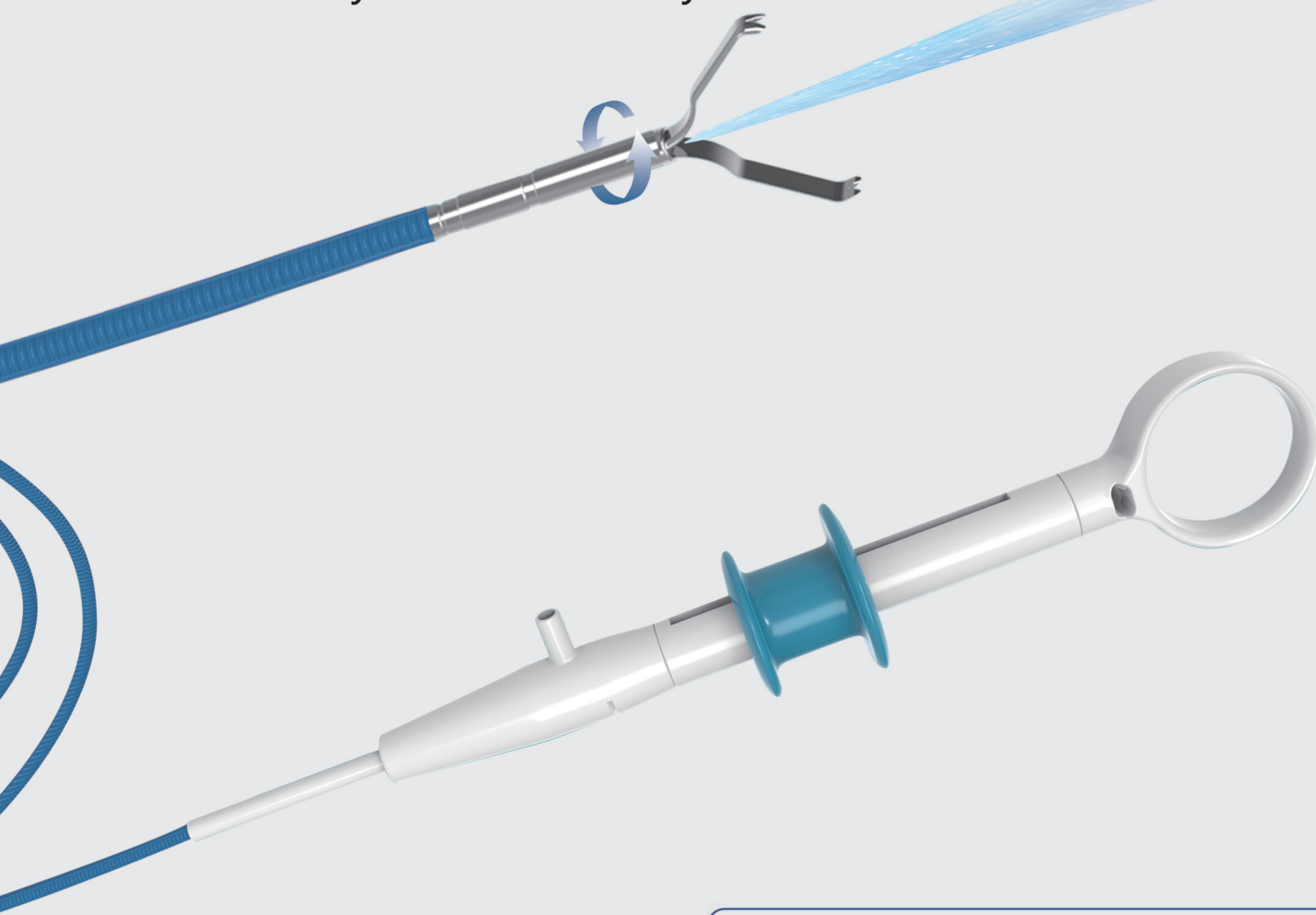

Used to clamp soft tissue in digestive tract  
under the guidance of clinical endoscopy

#### Special features:

- Rotatable clips design, offering a precise placement.
- Repeated opening and closing clips.
- Innovative design of handle lock system and atraumatic tip, avoid damage to scope after releasing clips.
- Sensitive release system, easy to release the clips.



**JIANGSU ATE MEDICAL TECHNOLOGY CO., LTD**  
No. 8, Lanxiang Road  
Wujin Economic Development Zone  
213000 Jiangsu, China

Tel: +86-519-85288988  
Fax: +86-519-85288060  
E-Mail: [sales@ate-medical.com](mailto:sales@ate-medical.com)  
Web: [www.ate-medical.com](http://www.ate-medical.com)

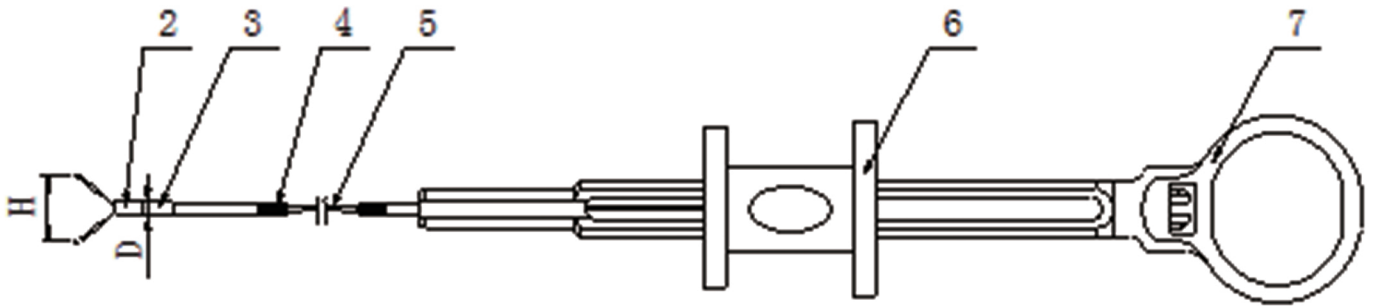
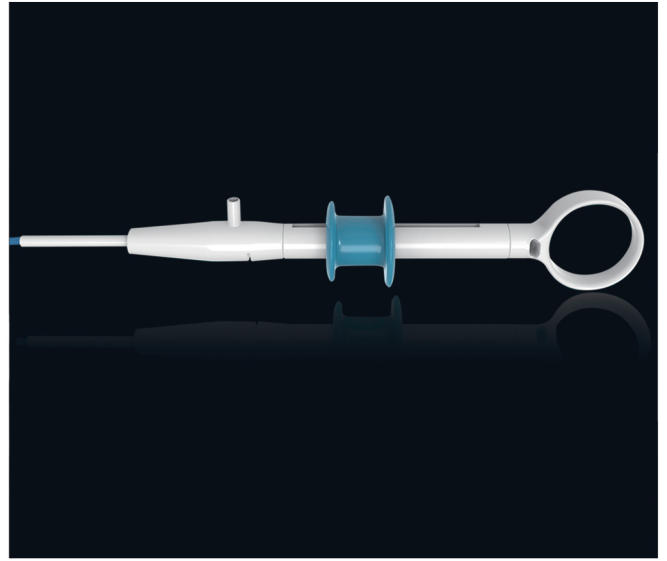
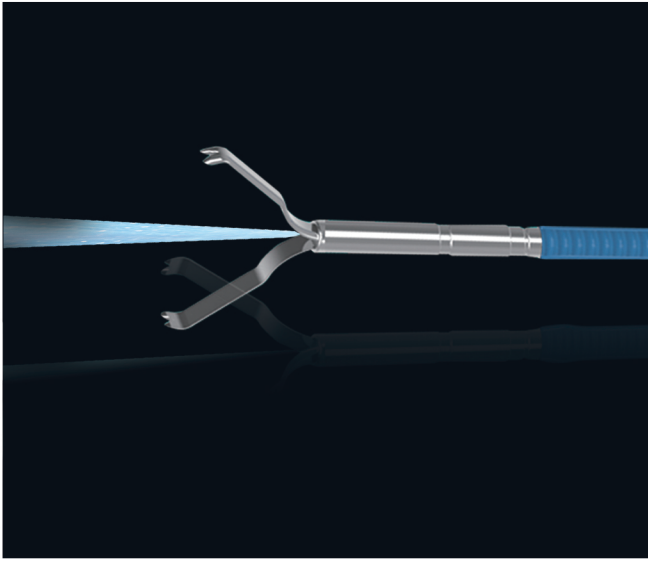

Repeatable opening and closing, 360°bidirectional synchronous rotation control.  
Excellent clamping strength .

	Model	OD(mm)	Length(mm)	Actual opening width
	ATE-ZXJ-2300*16	2.1	2300	16
	ATE-ZXJ-1600*16	2.1	1600	16



# Spray pipe

The solution for safe chromoendoscopy.



The staining of mucosa in the gastrointestinal tract contributes to an improved defining of details. Suspicious areas or tissue changes can be determined more reliably. The spray pipes GA-OTOTEC help to apply the staining solution precisely.

The innovative spray tip ensures efficient application of the liquid – either as an all-over spray by fine nozzles or as a concentrated jet for precise staining.

## Special features:

- High-quality manufacture and kink resistant
- Easy to use and quick to deploy
- Smooth insertion of the catheter
- Efficient application of the solution through fine nozzles
- Two innovative spray heads available



**JIANGSU ATE MEDICAL TECHNOLOGY CO., LTD**  
No. 8, Lanxiang Road  
Wujin Economic Development Zone  
213000 Jiangsu, China



Tel: +86-519-85288988  
Fax: +86-519-85288060  
E-Mail: [sales@ate-medical.com](mailto:sales@ate-medical.com)  
Web: [www.ate-medical.com](http://www.ate-medical.com)

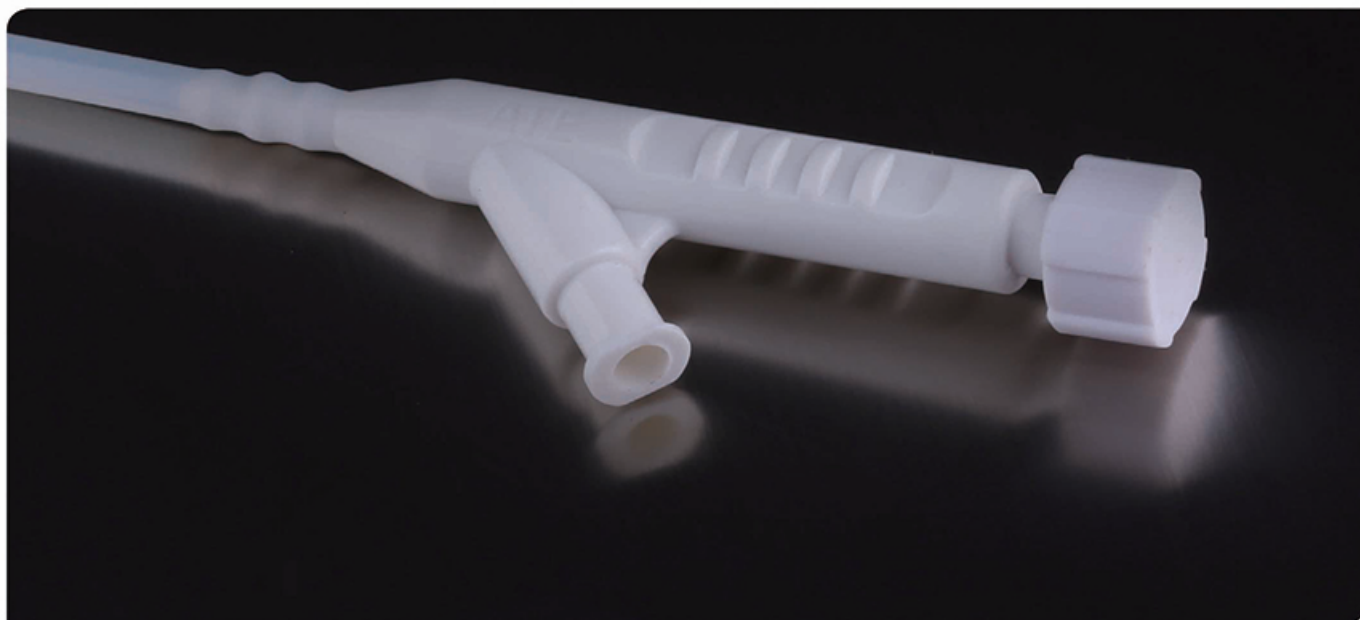



## Safe and easy insertion.

The introduction of the spray pipe in the endoscope is easy and safe. Thanks to the kink-resistant material the catheter adapts at each turn of the endoscope. To use the staining solution the catheter is equipped with a Y-cannula.

	Model	Diameter of the outer tube(mm)	Length(mm)
	<b>Jet spray</b>		
	ATE-PSG-Z-18x1200	1.8	1200
	ATE-PSG-Z-18x1800	1.8	1800
	ATE-PSG-Z-23x1600	2.3	1600
	ATE-PSG-Z-23x2300	2.3	2300
	<b>Mist spray</b>		
	ATE-PSG-W-18x1200	1.8	1200
	ATE-PSG-W-18x1800	1.8	1800
	ATE-PSG-W-23x1600	2.3	1600
	ATE-PSG-W-23x2300	2.3	2300

Distributed by



**JIANGSU ATE MEDICAL TECHNOLOGY CO., LTD**

No. 8, Lanxiang Road  
Wujin Economic Development Zone  
213149 Jiangsu, China

Tel: +86-519-85288988 E-Mail: [sales@ate-medical.com](mailto:sales@ate-medical.com)  
Fax: +86-519-85288060 Web: [www.ate-medical.com](http://www.ate-medical.com)



Vision No:2017-06-06